

RoHS
COMPLIANT

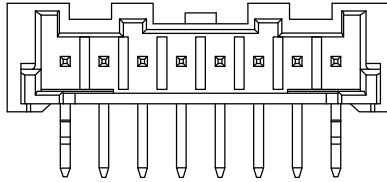

8P View

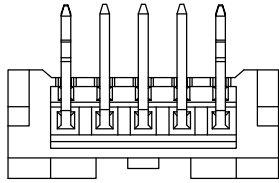
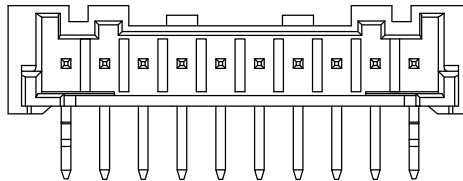
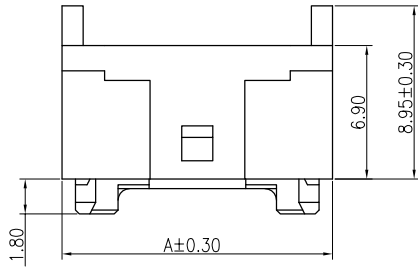

10P-15P View

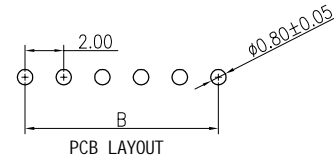
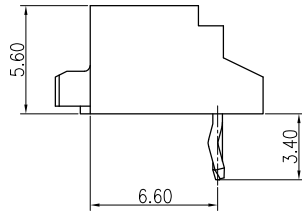
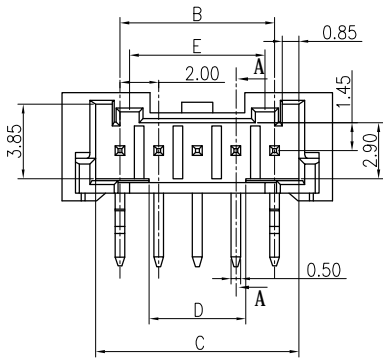

◆SPECIFICATIONS

- Current rating: 3A (AWG #22)AC, DC
- Voltage rating: 250V AC,DC
- Temperature range: -40°C ~ +105°C
- Insulation resistance:1000MΩ Min.
- Withstanding voltage: 800V AC/ minute.
- Contact resistance: 10mΩ Max.

Material:

Insulator: Nylon 9T UL 94V-0

Pin: Brass

Plating: Tin plated over Nickel

Suitable: KR2014 series Housing

PART NO: C2014RD1**11M0101PA

- 02: 2P
- 16: 16P
- 11: PA9T本色
- M01: 雾锡
- P: 袋装

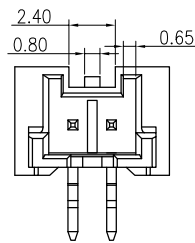
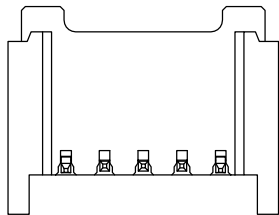

2P View

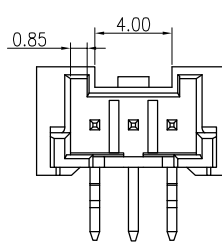

3P View

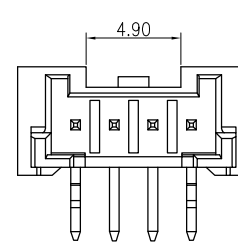

4P View

15P	34.00	28.00	30.50	23.00	13.60
14P	32.00	26.00	28.50	21.00	13.60
13P	30.00	24.00	26.50	19.00	13.60
12P	28.00	22.00	24.50	17.00	13.60
11P	26.00	20.00	22.50	15.00	13.60
10P	24.00	18.00	20.50	13.00	13.60
9P	22.00	16.00	18.50	11.00	7.00
8P	20.00	14.00	16.50	9.00	7.00
7P	18.00	12.00	14.50	7.00	7.00
6P	16.00	10.00	12.50	5.00	7.00
5P	14.00	8.00	10.50	5.00	7.00
4P	12.00	6.00	8.50	5.00	---
3P	10.00	4.00	6.50	1.00	---
2P	8.00	2.00	4.50	---	---
PIN数	A	B	C	D	E



MARK

更改料号及图框格式

新发行

1

2

3

4

5

6

7

8

9

TOLERANCE

- X. X ±0.30
- X. XX ±0.25
- X. XXX ±0.10
- Angle ±2°

TITLE:

PA2.0 DIP 90° WF

UNIT: mm

SCALE: N/A

DRAWN: ru yi 2020.03.10

CHECKED:

APPROVED:

SHEET: 1/1

PROJECTION

KONNRA 东莞市康瑞电子有限公司
DongGuan Konnra Electronics Co., Ltd.

PART NO.: C2014RD1**11M0101PA

REV.: A2 DRAWING NO.: 2014WFHD01-A-S