

RoHS  
COMPLIANT

SPECIFICATIONS

1. Current rating: 3A (AWG #24)AC, DC
2. Voltage rating: 100V AC,DC
3. Temperature range: -40°C ~ +105°C
4. Insulation resistance:500MΩ Min.
5. Withstanding voltage: 500V AC/ minute.
6. Contact resistance: 20mΩ Max..

Material:

Insulator: PA9T UL 94V-0  
Pin: Phosphor bronze  
Fitting Nail: Brass

Plating: Tin plated over Nickel

Mate with KR1507 series Housing

PART NO: C1507RS1\*\*11M0101RA

02: 2P  
16: 16P  
11: PA9T本色  
M01: 雾锡  
R: 卷装  
P: 袋装

15P	26.80	21.00	23.90	5.20	
14P	25.30	19.50	22.40	5.20	
13P	23.80	18.00	20.90	5.20	
12P	22.30	16.50	19.40	5.20	3.65
11P	20.80	15.00	17.90	5.20	
10P	19.30	13.50	16.40	3.20	
9P	17.80	12.00	14.90	3.20	
8P	16.30	10.50	13.40	2.50	3.25
7P	14.80	9.00	11.90	2.50	2.50
6P	13.30	7.50	10.40	2.30	2.15
5P	11.80	6.00	8.90	—	3.60
4P	10.30	4.50	7.40	—	3.30
3P	8.80	3.00	5.90	—	2.55
2P	7.30	1.50	4.40	—	1.85
PIN数	A	B	C	D	E

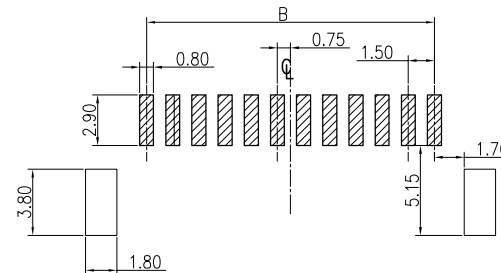
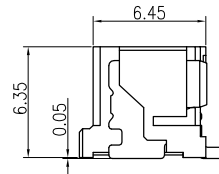
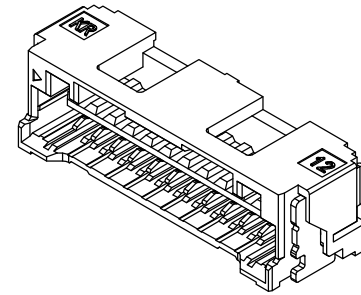

Recommended P.C.B. Layout  
Total tolerance:±0.05mm

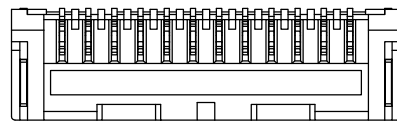
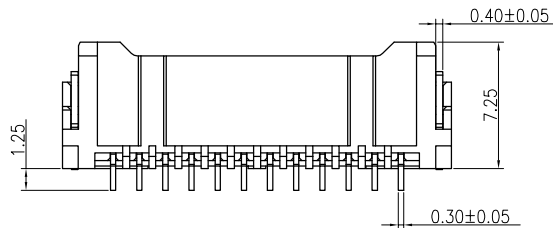
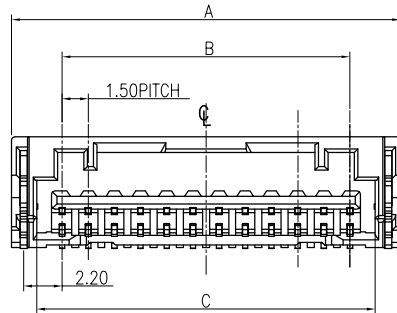
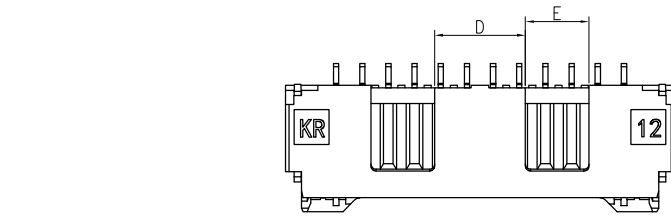

F	A3	更改规格参数	Arvin	2020.11.20	TOLERANCE X. X ±0.30 X. XX ±0.20 X. XXX ±0.10 Angle ±2°	TITLE: MX1.5 SMT 90° 内扣WF	DRAWN: ru yi 2020.03.10		KONNRA 东莞市康瑞电子有限公司		
	A2	更改料号及图框格式	Ru yi	2020.3.10			CHECKED:		DongGuan Konnra Electronics Co., Ltd.		
	A1	首版发行图面	Ru yi	2018.11.20			APPROVED:		PART NO.: C1507RS1**11M0101RA		
	MARK	REVISION DESCRIPTION	SIGNATURE	DATE			UNIT: mm	SCALE: N/A	SHEET: 1/2	PROJECTION	REV.: A3

1 2 3 4 5 6 7 8 9

**RoHS**  
COMPLIANT

2P视图

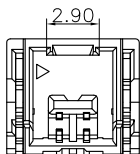

3P视图

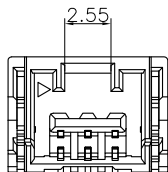

4P视图

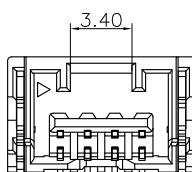

5P视图

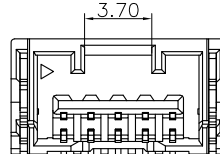

6P视图

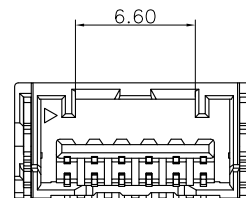

7P视图

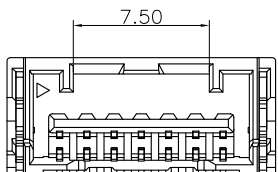

8P视图

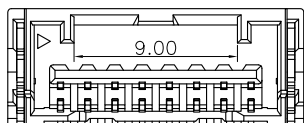

9P视图

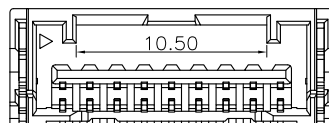

10P视图



11P视图



13P视图

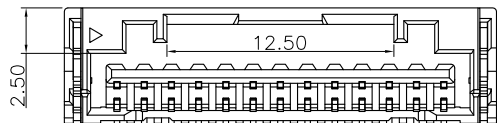

14P视图

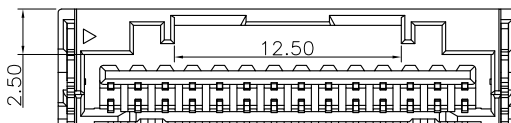

15P视图

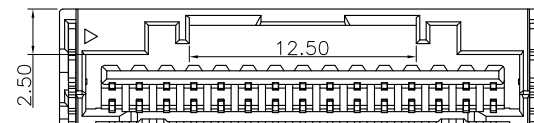

A3

更改料号及图框格式

Ru yi

2020.3.10

TOLERANCE  
X.X ±0.30  
X.XX ±0.20  
X.XXX ±0.10  
Angle ±2°

TITLE:  
MX1.5 SMT 90°  
内扣WF

DRAWN: ru yi 2020.03.10

CHECKED:

APPROVED:

**KONNRA** 东莞市康瑞电子有限公司  
DongGuan Konnra Electronics Co.,Ltd.

PART NO.: C1507RS1\*\*11M0101RA

MARK

REVISION DESCRIPTION

SIGNATURE

DATE

UNIT:mm SCALE:N/A

SHEET:2/2 PROJECTION

REV.:A2

DRAWING NO.:1507WHS101-A-S

1

2

3

4

5

6

7

8

9