

QG030-148/14

DC tangential blower

forward curved



ebm-papst St. Georgen GmbH & Co. KG

Hermann-Papst-Str. 1

D-78112 St. Georgen

Phone +49 (0) 7724 81-0

Fax +49 (0) 7724 81-1309

info2@de.ebmpapst.com

www.ebmpapst.com

Nominal data

Type	QG030-148/14	
Nominal voltage	VDC	24
Nominal voltage range	VDC	16 .. 28
Power input	W	6.2
Min. ambient temperature	°C	-20
Max. ambient temperature	°C	60
Air flow	m ³ /h	75
Sound power level	B	5.7
Sound pressure level	dB(A)	49

mi = Max. load · me = Max. efficiency · fa = Running at free air · cs = Customer specs · cu = Customer unit
Subject to alterations



Technical features

Mass	0.235 kg
Material of impeller	Aluminum
Housing material	Aluminum, housing side parts of plastic.
Direction of rotation	Right, looking at rotor
Bearing	Motor with ball bearing system. Impeller bracket with sliding bearings.
Lifetime L10 at 40 °C	30000 h
Lifetime L10 at maximum temperature	10000 h
Motor protection	Protected against reverse polarity and locking.
Locked-rotor protection	Blocking and overload protection
Approval	VDE, CSA, UL, CE

Product drawing

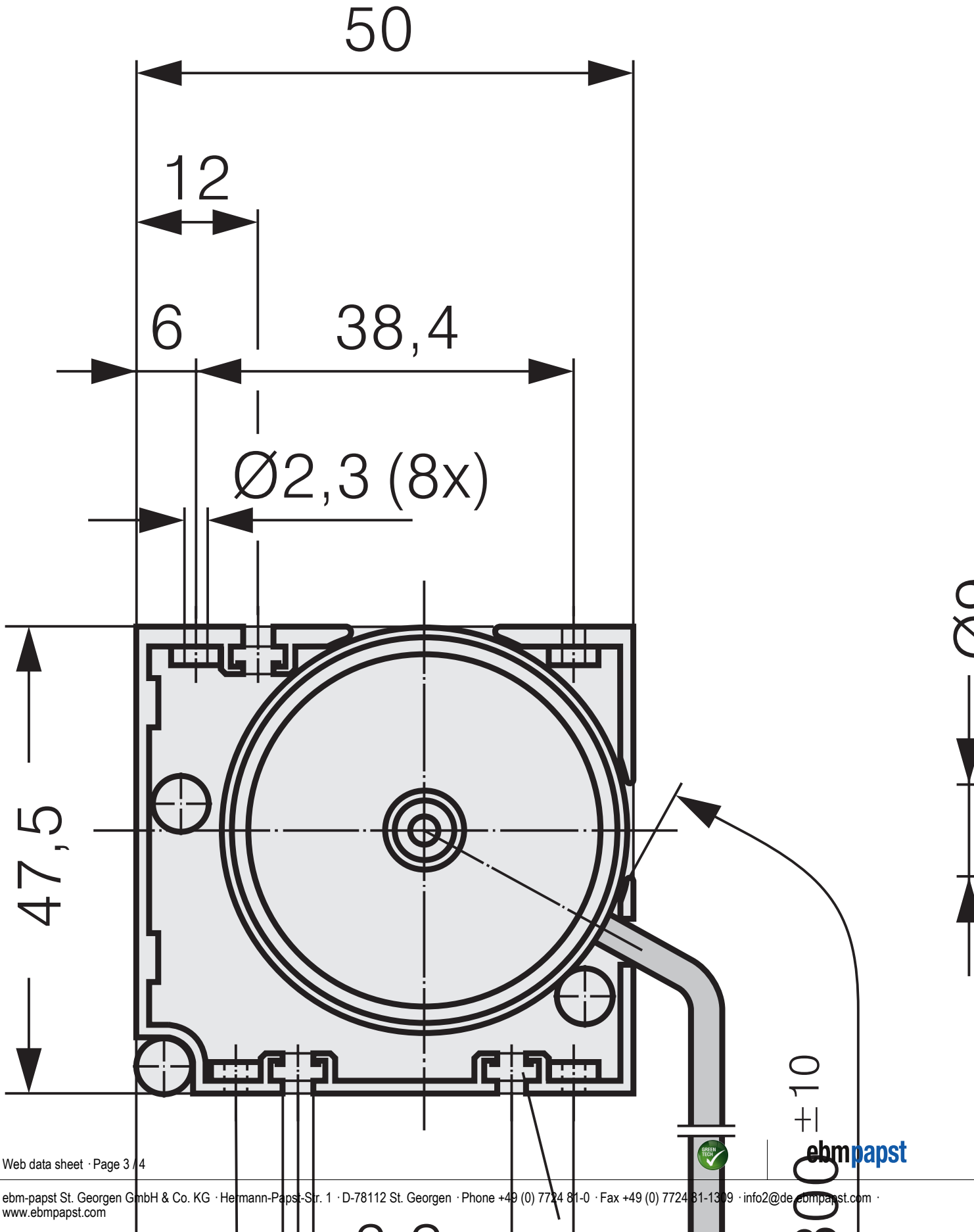

Charts: Air flow

